

PYLE

PyleUSA.com



PWMA325BT PORTABLE BLUETOOTH KARAOKE SPEAKER SYSTEM

Instruction Manual

I. FEATURES

1. Ultra-large magnetic circuit high-sensitivity speaker with high penetrating power, low-frequency shock and perfect medium-/high-frequency representation
2. The latest decoding chips supporting stable playback of MP3 up to 32GB U disk/TF card.
3. FM radio reception - high-quality digital radio with automatic channel search and storage of up to 60 channels.
4. 3.5mm AUX audio input for each connection to a wide range of sound sources.
5. Built-in high-capacity battery for consecutive playback of up to 2 hours.
6. Connect the microphone, adjustable reverberation, voice and Karaoke function to present outstanding performance.
7. Battery with built-in recharging protection to present a long and stable service life.
8. Built-in low battery and full recharging indication.
9. With belt / handle design for easy transportation and high mobility.
10. Outputs to earphone or external sound sources.
11. Record your favorite FM radio station or other AUX sound source to enjoy the music wherever you like.
12. Microphone input recording to act as your personal business assistant.
13. With Bluetooth function.

II. RECORDING

Recording via External Microphone:

Connect a storage device (USB/TF card) and short press RECORD key to start recording for a time depending on the storage capacity. During recording, tune the “-ECHO+” knob to minimum. It is best that the microphone should have a proper distance away from the speaker to prevent any feedback.

Notes:This product starts recording from the time record is displayed on the LED screen.

III. BLUETOOTH PAIRING OPERATION:

1. ON/OFF: switch the power to ON, press the key “MODE” to enter the mode of Bluetooth, the display screen will show “BLUE”.
2. Make sure the Bluetooth function of the Mobile device is active and begin searching, Connect to mobile device when “PyleUSA” shows. Mobile device connections do not need password, however if prompted, input “0000” to go on pairing. After a successful pairing, the speaker will send out a voice prompt indicating it has successfully been paired with the mobile device.
3. Play the music from your mobile device directly and enjoy.

IV. FUNCTIONAL OPERATIONS AND FEATURES

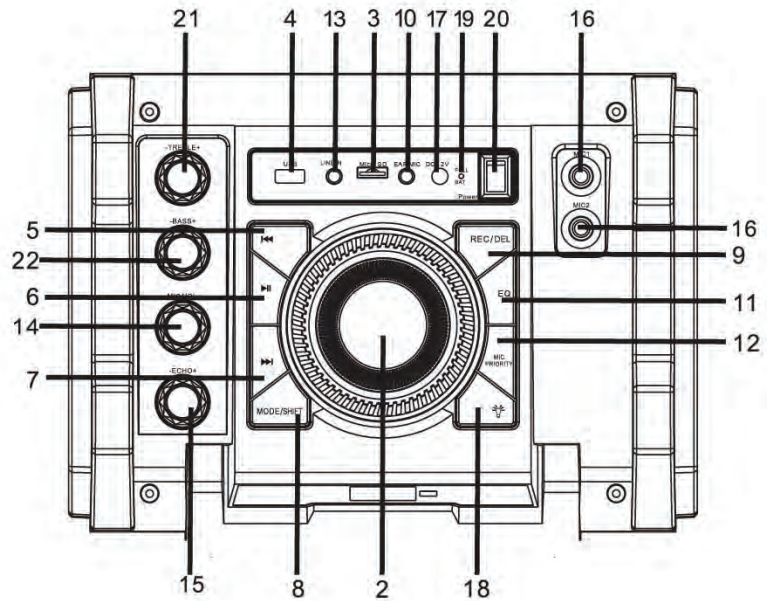
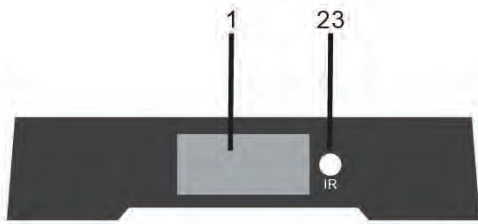

1. LED Screen
2. **Master Volume:** In MP3/FM/AUX mode, use it to regulate volume output from the speaker.
3. **TF Port:** Read audio files in MP3 format in TF card in capacity up to 32GB (FAT32).
4. **USB Port:** Read audio files in MP3 format in USB storage device in capacity up to 32GB (FAT32).
5. **◀◀:** In FM receiving status, short press it to select the previous channel after a full station search has been executed.
6. **▶▶:** In USB/TF card reading status, short press it to play/pause, or long press it to select one of four playback sequencing modes (All - play all tracks in sequence; ONE - repeat one track). In FM receiving status, long press it to execute a full search (it is recommended to execute at least one full search before using radio receiving function. All founded stations will be saved even in power-off). In AUX input / FM radio status, short press it to toggle between mute and normal volume.
7. **▶||:** In USB/TF card reading status, short press it to go to the previous track. In FM receiving status, short press it to select the next channel after a full station search has been executed.
8. **Mode/SHIFT:** Short press it to toggle between USB/TF and FM receiving modes. Long press it to toggle between recording folder and MP3 folder.
9. **Recording/DEL:** Short press it to enable recording (USB/TF storage device need be connected first). During recording, reverberation should be tuned to the minimum. Long press it to delete a recording file. Recording in AUX or FM mode is available.
10. **EAR MIC:** Headphone/MIC Port
11. **EQ:** Environment Switching: In USB/TF reading status, short press it to select an environment mode (from Square, Meeting, Home, Hall and Personal).
12. **MIC PRIORITY:** Connect the microphone, short press the key, into the microphone priority mode
13. **LINE IN:** External sound source input port (plug-and-play).







14. **Microphone volume:** Microphone volume regulating knob.
15. **Reverberation:** Microphone reverberation regulating knob.
16. **Microphone input:** Microphone input jack
17. **DC 12V recharging:** DC 12V recharging port.
18.  : Press it to control the flash light switch.
19. **Recharging indicator light:** When recharger is connected, the red light turns on. When the device is fully recharged, the blue light turns on.
20. **Power switch:** “— ” - ON; ‘○ ” - OFF.
21. **TREBLE:** The control knob of treble
22. **BASS:** The control knob of bass
23. **IR:** Infrared remote receiver module

CAUTION:

Please be sure to charge while music distorted.

V. REMOTE INSTRUCTIONS:



1. **Power Button:** Short press it to enter standby mode; short press it again to resume. If no device is connected, the system goes to “-NO-”.
2.  : Functions as “  ” on the master device.
3.  : Functions as “  ” on the master device.
4.  : Functions as “  ” on the master device.
5. **Mode:** Functions as “Mode” on the master device.
6. **V+/V- Keys:** In USB/TF/FM/AUX mode, press them to volume up/down.
7. **Numeric Keys 0~9:** In USB/TF card reading status, to play Track 12, just input numbers “1” and “2”, and in 2 seconds the system will go to Track 12 and start playback. Any input of number larger than number of the total available tracks is invalid. In FM status, to listen to channel 107.5MHZ, just input “1075”.
8. **Environment Key:** In USB/TF card reading status, short press it to toggle among Square, Meeting, Home, Hall and Personal modes.
9. **Sequencing Key:** In USB/TF card reading status, short press it to toggle among four playback sequencing modes (All - play all tracks in sequence; RAND - play in random; ONE - repeat one track; FOL - repeat all tracks in a folder).
10.  In USB/TF/FM/AUX mode, short press it to mute the device.
11. **100+:** Number selection key - in MP3 mode (USB/TF card), short press it to add “100” to current track number.



VISIT US ONLINE:

Have a question?

Need service or repair?

Want to leave a comment?

PyleUSA.com/ContactUs

PYLE